



# PANELEIRO 1 PORTA TORRE ANGULAR NESHER REALEZA PREMIUM 65CM 100% MDF

NESHER REALEZA PREMIUM 65CM 100 MDF CORNER TOWER CABINET WITH 1 DOOR  
ALACENA EN TORRE ESQUINERA DE 1 PUERTA NESHER REALEZA PREMIUM 65CM 100 MDF



A marca da gestão florestal responsável

The mark of responsible forest management

La marca de la gestión forestal responsable

FSC® C168299

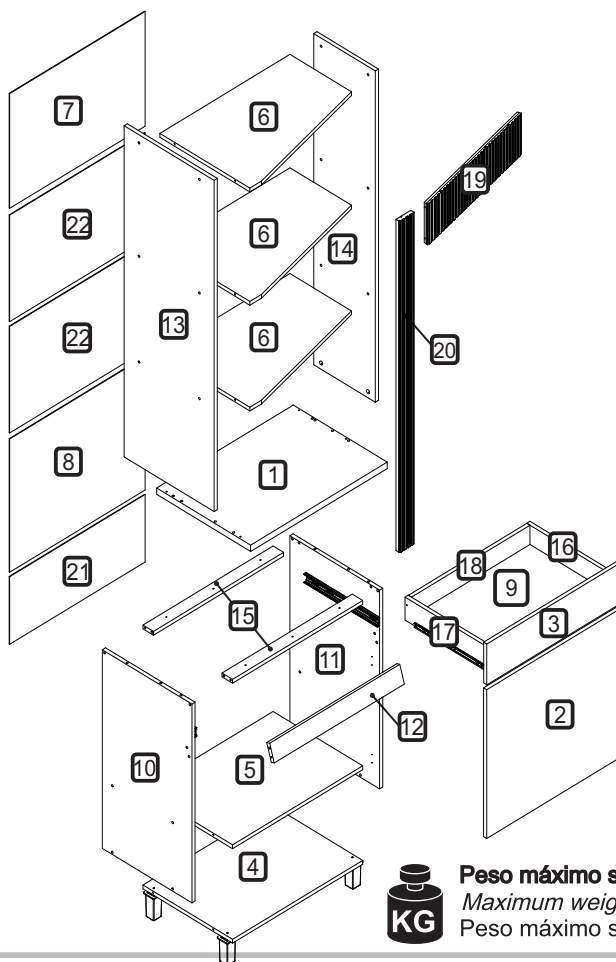
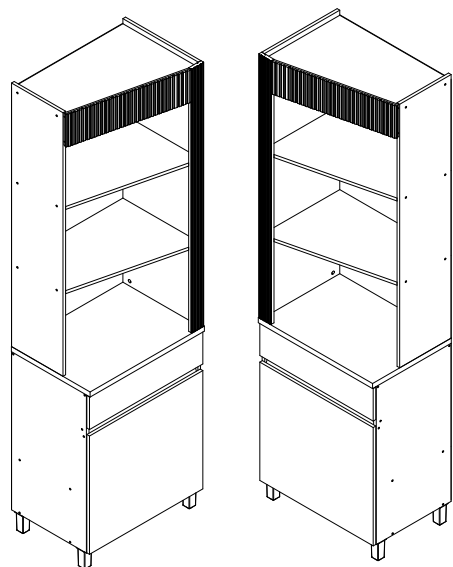

**Peso máximo suportado**  
Maximum weight supported  
Peso máximo suportado

ESTE PRODUTO PERMITE MONTAGEM PARA AMBOS OS LADOS.  
THIS PRODUCT ALLOWS FOR ASSEMBLY ON BOTH SIDES.  
ESTE PRODUCTO PUEDE MONTARSE POR AMBOS LADOS.

**DIMENSÕES MÁXIMAS DO PRODUTO MONTADO**  
MAXIMUM DIMENSIONS OF THE ASSEMBLED PRODUCT  
DIMENSIONES MÁXIMAS DEL PRODUCTO MONTADO

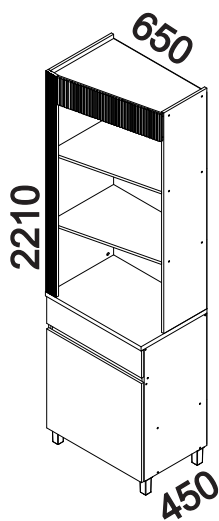



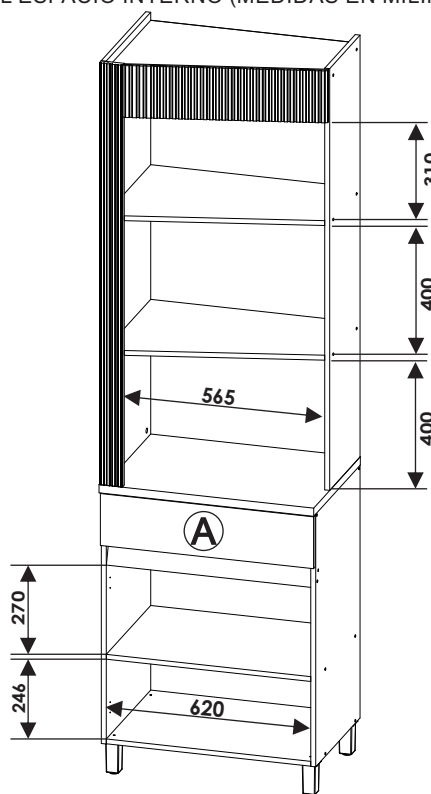





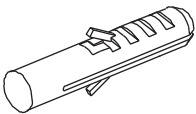

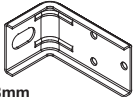
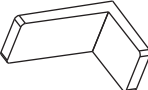
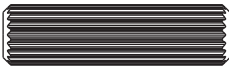
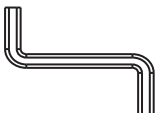

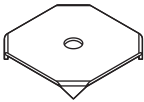
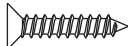
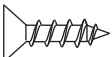
**DIMENSÕES DOS ESPAÇOS INTERNOS (MEDIDAS EM MILÍMETROS)**  
DIMENSIONS OF INTERNAL SPACES (MEASUREMENTS IN MILLIMETERS)  
DIMENSIONES DEL ESPACIO INTERNO (MEDIDAS EN MILÍMETROS)

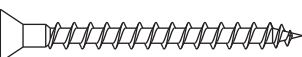

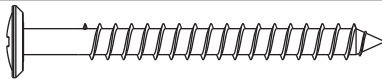
**ESPAÇO INTERNO DAS GAVETAS**  
(largura x altura x profundidade)  
**INTERNAL SPACE OF DRAWERS**  
(width x height x depth)  
**ESPACIO INTERNO DE LOS CAJONES**  
(ancho x alto x profundidad)  
Ⓐ 565 x 384 x 76 mm

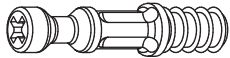
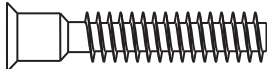
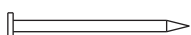
CÓDIGO CODE CÓDIGO	CARVALHO/GREIGE CARVALHO/GREIGE CARVALHO/GREIGE	CARVALHO/TITANIO CARVALHO/TITANIO CARVALHO/TITANIO	DESCRIÇÃO DESCRIPTION DESCRIPCIÓN	MAT. PRIMA RAW MATERIAL MATERIA PRIMA	QUANT. QTY CANT	MEDIDAS MEASUREMENTS MEDICIONES		
1	403753	403753	BANCADA / COUNTERTOP / ENCIMERA	MDF	1	651	448	25
2	403769	403754	PORTA / DOOR / PUERTA	MDF	1	646	589	15
3	403770	403755	FRENTE DE GAVETA / DRAWER FRONT / FRENTE DE CAJÓN	MDF	1	646	160	15
4	403756	403756	BASE / BASE / BASE	MDF	1	620	427	15
5	403757	403757	PRATELEIRA INFERIOR / LOWER SHELF / REPISA INFERIOR	MDF	1	620	427	15
6	403758	403758	PRATELEIRA SUP - TAMPO CHANFRADO / UPPER SHELF - BEVELED TOP / REPISA SUPERIOR - TAPA BISELADA	MDF	3	620	429	15
7	403683	403683	FUNDO TRASEIRO / BACK PANEL / PANEL TRASERO	DURATREE	1	645	450	2.5
8	403684	403684	FUNDO TRASEIRO / BACK PANEL / PANEL TRASERO	DURATREE	1	645	523	2.5
9	403685	403685	FUNDO DE GAVETA / DRAWER BOTTOM / FONDO DE CAJÓN	DURATREE	1	577	398	2.5
10	403720	403720	LATERAL ESQ INFERIOR / LOWER LEFT SIDE PANEL / LATERAL IZQUIERDO INFERIOR	MDF	1	785	427	15
11	403719	403719	LATERAL DIR INFERIOR / LOWER RIGHT SIDE PANEL / LATERAL DERECHO INFERIOR	MDF	1	785	427	15
12	403761	403761	TRAVESSA FRONTAL / FRONT RAIL / TRAVESAÑO FRONTAL	MDF	1	620	70	15
13	403762	403762	LATERAL SUPERIOR MAIOR / UPPER LARGE SIDE PANEL / LATERAL SUPERIOR MAIOR	MDF	1	1.300	429	15
14	403763	403763	LATERAL SUPERIOR MENOR / UPPER SMALL SIDE PANEL / LATERAL SUPERIOR MENOR	MDF	1	1.300	293	15
15	403764	403764	TRAVESSA SUPERIOR / TOP RAIL / TRAVESAÑO SUPERIOR	MDF	2	620	50	15
16	403403	403403	LATERAL DE GAVETA DIREITA / RIGHT DRAWER SIDE / LATERAL DERECHA DEL CAJÓN	MDF	1	400	90	15
17	403404	403404	LATERAL DE GAVETA ESQUERDA / LEFT DRAWER SIDE / LATERAL IZQUIERDA DEL CAJÓN	MDF	1	400	90	15
18	403765	403765	TRASEIRO DE GAVETA / DRAWER BACK / PARTE TRASERA DEL CAJÓN	MDF	1	565	90	15
19	403767	403767	MOLDURA CANELADA / FLUTED FRAME / MOLDURA CANELADA	MDF	1	595	160	18
20	403768	403768	MOLDURA LATERAL CANELADA / FLUTED SIDE FRAME / MOLDURA LATERAL CANELADA	MDF	1	1.300	70	18
21	403681	403681	FUNDO TRASEIRO / BACK PANEL / PANEL TRASERO	DURATREE	1	645	272	2.5
22	403682	403682	FUNDO TRASEIRO / BACK PANEL / PANEL TRASERO	DURATREE	2	645	418	2.5

CÓDIGO/DESCRIÇÃO CODE/DESCRIPTION CÓDIGO/DESCRIPCIÓN	QUANTIDADE QUANTITY CANTIDAD	CÓDIGO/DESCRIÇÃO CODE/DESCRIPTION CÓDIGO/DESCRIPCIÓN	QUANTIDADE QUANTITY CANTIDAD
<b>F1</b> BATENTE DE SILICONE 12MM 12MM SILICONE BUMPER TOPE DE SILICONA 12MM 	4	<b>F2</b> BUCHA DE PAREDE PLÁSTICA DE 8mm 8mm PLASTIC WALL ANCHOR TACOS DE PARED PLASTIC DE 8mm 	6
<b>F3</b> CANTONEIRA METÁLICA DE FIXAÇÃO 18x12mm 18x12mm METAL CORNER BRACE CANTONERA DE FIJACIÓN METÁLICA 18x12mm 	2	<b>F5</b> CANTONEIRA METÁLICA PARA FIXAÇÃO NA PAREDE 54x28x28mm 54x28x28mm METAL CORNER BRACE FOR SECURING TO WALL CANTONERA METÁLICA PARA FIJACIÓN EN LA PARED 54x28x28mm 	6
<b>F6</b> CAPA PLÁSTICA PARA CANTONEIRA 55X30X30mm 55X30X30mm PLASTIC COVER FOR CORNER BRACE TAPA DE PLÁSTICO PARA ÂNGULO 55X30X30mm 	6 NATURE NATURE NATURE	<b>F7</b> CAVILHA DE MADEIRA 8X30mm 8X30mm WOODEN DOWEL PIN TARUGO DE MADEIRA DE 8X30mm 	18
<b>F9</b> CHAVE ZETA 4mm 4mm S-SHAPED HEX KEY LLAVE ZETA 4mm 	1	<b>F10</b> DISPOSITIVO FIXADOR DE FUNDO DE PLÁSTICO 15x14x12mm 15x14x12mm PLASTIC DRAWER EDGE FASTENING DEVICE DISPOSITIVO SUJETADOR DEL FONDO DE PLÁSTICO 15x14x12mm 	4
<b>F11</b> FIXADOR TRASEIRO METÁLICO 14x14mm 14x14mm METAL BACK PANEL FASTENER SUJETADOR METÁLICO DEL FONDO POSTERIOR 14x14mm 	25	<b>F14</b> PARAFUSO PHILIPS 3x16mm CABEÇA CHATA PHILIPS SCREW 3x16 mm FLAT HEAD TORNILLO PHILIPS 3x16 mm CABEZA PLANA 	4
<b>F15</b> PARAFUSO PHILIPS 3,5x14mm CABEÇA CHATA PHILIPS SCREW 3,5x14 mm FLAT HEAD TORNILLO PHILIPS 3,5x14 mm CABEZA PLANA 	12	<b>F18</b> PARAFUSO PHILIPS 3,5x30mm CABEÇA CHATA PHILIPS SCREW 3,5x30 mm FLAT HEAD TORNILLO PHILIPS 3,5x30 mm CABEZA PLANA 	6
<b>F19</b> PARAFUSO PHILIPS 3,5x40mm CABEÇA CHATA PHILIPS SCREW 3,5x40 mm FLAT HEAD TORNILLO PHILIPS 3,5x40 mm CABEZA PLANA 	2	<b>F23</b> PARAFUSO PHILIPS 4x14mm CABEÇA PANELA PHILIPS SCREW 4x14 mm PAN HEAD TORNILLO PHILIPS 4x14 mm CABEZA ALOMADA 	48
<b>F22</b> PARAFUSO PHILIPS 5x50mm CABEÇA FLANGEADA PHILIPS SCREW 5x50 mm FLANG HEAD TORNILLO PHILIPS 5x50 mm CABEZA CON BRIDA 	10	<b>F25</b> PARAFUSO UNIÃO 28mm 28mm CONNECTOR SCREW TORNILLO DE UNIÃO 28mm 	4
<b>F27</b> PARAFUSO MINIFIX 6x30mm 6x30mm CAM LOCK SCREW TORNILLO MINIFIX 6x30mm 	7	<b>F28</b> PARAFUSO ALLEN S_PONTA 7x40mm CABEÇA CHATA ALLEN SCREW WITH/OUT TIP 7x40 mm FLAT HEAD TORNILLO ALLEN SIN PUNTA 7x40 mm CABEZA PLANA 	26
<b>F29</b> PREGO 10X10 COM CABEÇA 10x10 NAIL WITH HEAD CLAVO CON CABEZA DE 10x10 	75	<b>F31</b> SUPORTE ANGULAR PLÁSTICA 22x15x12mm 22x15x12mm PLASTIC ANGLE BRACKET ESCUADRA DE ÂNGULO PLASTIC 22x15x12mm 	9 NATURE NATURE NATURE