

nesh
cozinhas moduladas

BALCÃO 2 PORTAS 1 GAVETA
NESHER REALEZA PREMIUM 80CM 100% MDF

NESHER REALEZA PREMIUM BASE CABINET W/ 2 DOOR 1 DRAWER 80 CM 100% MDF
MOSTRADOR 2 PUERTAS 1 CAJÓN NESHER REALEZA PREMIUM DE 80 CM 100 % MDF



A marca da gestão florestal responsável
The mark of responsible forest management
La marca de la gestión forestal responsable
FSC • C168299

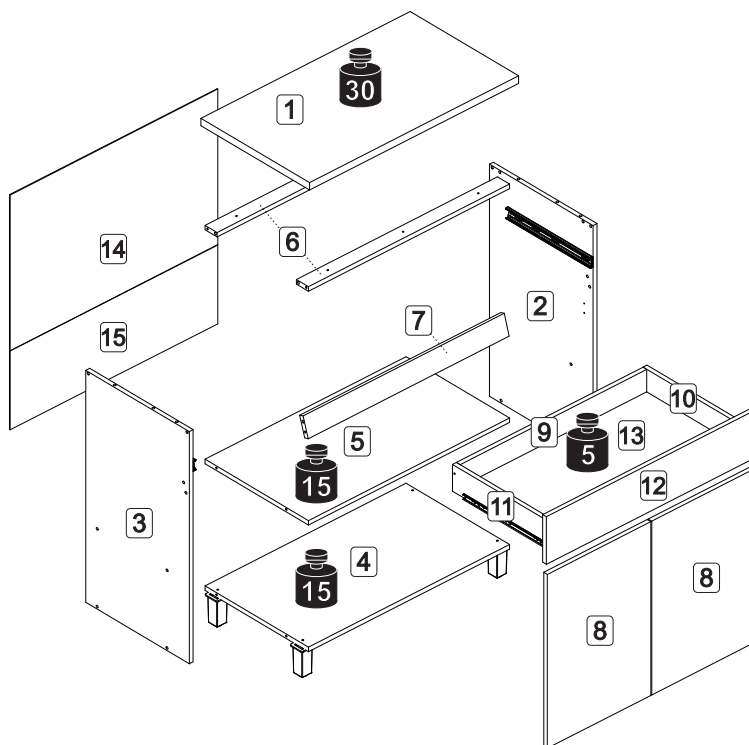
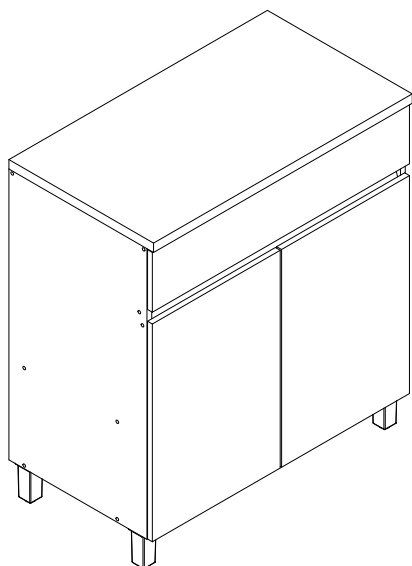

KG Peso máximo suportado
Maximum weight supported
Peso máximo suportado

DIMENSÕES MÁXIMAS DO PRODUTO MONTADO

MAXIMUM DIMENSIONS OF THE ASSEMBLED PRODUCT

DIMENSIONES MÁXIMAS DEL PRODUCTO MONTADO

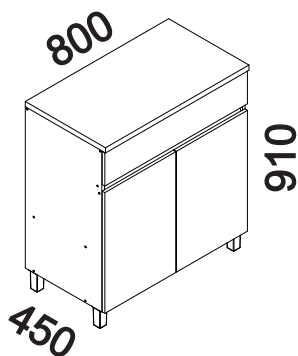

ESPAÇO INTERNO DAS GAVETAS (largura x altura x profundidade)

INTERNAL SPACE OF DRAWERS (width x height x depth)

ESPACIO INTERNO DE LOS CAJONES (ancho x alto x profundidad)

Ⓐ 715 x 76 x 384 mm

DIMENSÕES DOS ESPAÇOS INTERNOS (MEDIDAS EM MILÍMETROS)





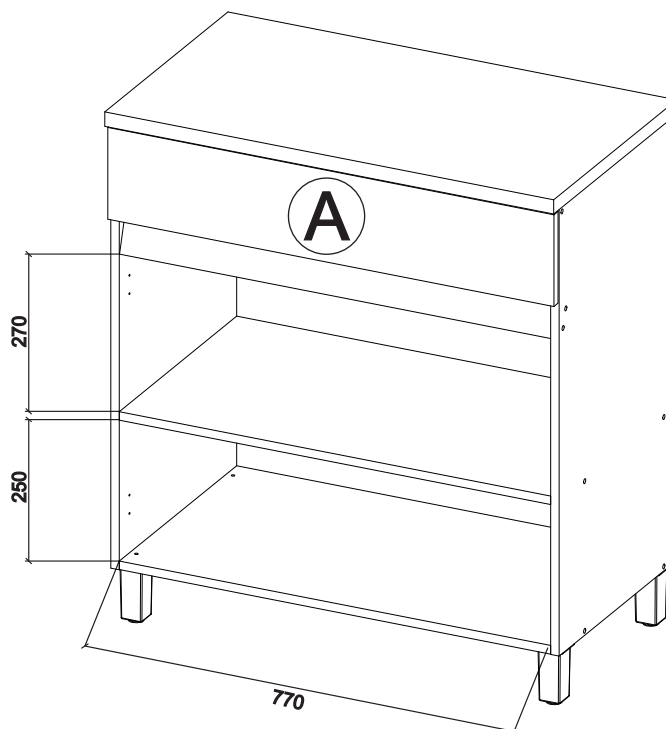





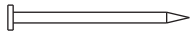
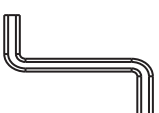

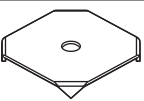
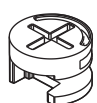

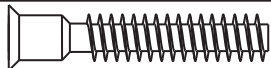
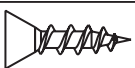
DIMENSIONS OF INTERNAL SPACES (MEASUREMENTS IN MILLIMETERS)

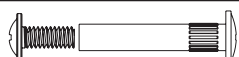
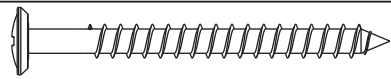
DIMENSIONES DEL ESPACIO INTERNO (MEDIDAS EN MILÍMETROS)

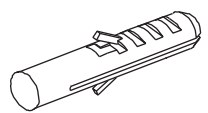

CÓDIGO CODE CÓDIGO	CARVALHO/GREIGE CARVALHO/GREIGE CARVALHO/GREIGE	CARVALHO/TITANIO CARVALHO/TITANIO CARVALHO/TITANIO	DESCRIÇÃO DESCRIPTION DESCRIPCIÓN	MAT. PRIMA RAW MATERIAL MATERIA PRIMA	QUANT. QTY CANT	MEDIDAS MEASUREMENTS MEDICIONES
1	403718	403718	BANCADA / WORKTOP / ENCIMERA	MDF	1	801 448 25
2	403719	403719	LATERAL DIREITA / RIGHT SIDE / LATERAL DERECHO	MDF	1	785 427 15
3	403720	403720	LATERAL ESQUERDA / LEFT SIDE / LATERAL IZQUIERDO	MDF	1	785 427 15
4	403721	403721	BASE / BASE / BASE	MDF	1	770 427 15
5	403722	403722	PRATELEIRA / SHELF / ESTATE	MDF	1	770 427 15
6	403520	403520	TRAVESSA SUPERIOR / UPPER CROSSPIECE / LARGUERO SUPERIOR	MDF	2	770 50 15
7	403519	403519	TRAVESSA FRONTAL / FRONT CROSSPIECE / LARGUERO DELANTERO	MDF	1	770 70 15
8	403713	403716	PORTA / DOOR / PUERTA	MDF	2	589 397 15
9	403723	403723	TRASEIRO DE GAVETA / CROSSPIECE OF DRAWER / LARQUERO DEL CAJÓN	MDF	1	715 90 15
10	403403	403403	LATERAL DE GAVETA DIREITA / RIGHT SIDE OF DRAWER / LATERAL DERECHO DEL CAJÓN	MDF	1	400 90 15
11	403404	403404	LATERAL DE GAVETA ESQUERDA / LEFT SIDE OF DRAWER / LATERAL IZQUIERDO DEL CAJÓN	MDF	1	400 90 15
12	403724	403726	FRENTE GAVETA / DRAWER FRONT / FRENTE DEL CAJÓN	MDF	1	796 160 15
13	402766	402766	FUNDO DE GAVETA / DRAWER BOTTOM / FONDOMDEL CAJÓN	DURATREE	1	729 398 2.5
14	403676	403676	FUNDO / BACK PANEL / FONDO POSTERIOR	DURATREE	1	795 523 2.5
15	403677	403677	FUNDO / BACK PANEL / FONDO POSTERIOR	DURATREE	1	795 272 2.5

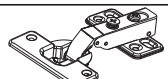
CÓDIGO/DESCRIÇÃO CODE/DESCRIPTION CÓDIGO/DESCRIPCIÓN	QUANTIDADE QUANTITY CANTIDAD	CÓDIGO/DESCRIÇÃO CODE/DESCRIPTION CÓDIGO/DESCRIPCIÓN	QUANTIDADE QUANTITY CANTIDAD
--	------------------------------------	--	------------------------------------

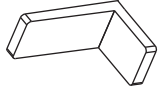
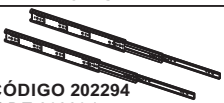
F29 PREGO 10X10 COM CABEÇA 10x10 NAIL WITH HEAD CLAVO CON CABEZA DE 10x10		40	F9 CHAVE ZETA 4mm 4mm S-SHAPED HEX KEY LLAVE ZETA 4mm		1
F5 CANTONEIRA METÁLICA PARA FIXAÇÃO NA PAREDE 54x28x28mm 54x28x28mm METAL CORNER BRACE FOR SECURING TO WALL CANTONERA METÁLICA PARA FIJACIÓN EN LA PARED 54x28x28mm		4	F11 FIXADOR TRASEIRO METÁLICO 14x14mm 14x14mm METAL BACK PANEL FASTENER SUJETADOR METÁLICO DEL FONDO POSTERIOR 14x14mm		8
F32 TAMBOR MINIFIX 15mm 15mm CAM LOCK NUT TAMBOR MINIFIX 15mm		3	F18 PARAFUSO PHILIPS 3,5x30mm CABEÇA CHATA PHILIPS SCREW 3,5x30 mm FLAT HEAD TORNILLO PHILIPS 3,5x30 mm CABEZA PLANA		6
F19 PARAFUSO PHILIPS 3,5x40mm CABEÇA CHATA PHILIPS SCREW 3,5x40 mm FLAT HEAD TORNILLO PHILIPS 3,5x40 mm CABEZA PLANA		2	F28 PARAFUSO ALLEN S. PONTA 7x40mm CABEÇA CHATA ALLEN SCREW WITOUH TIP 7x40 mm FLAT HEAD TORNILLO ALLEN SIN PUNTA 7x40 mm CABEZA PLANA		14
F15 PARAFUSO PHILIPS 3,5x14mm CABEÇA CHATA PHILIPS SCREW 3,5x14 mm FLAT HEAD TORNILLO PHILIPS 3,5x14 mm CABEZA PLANA		12	F14 PARAFUSO PHILIPS 3,5x16mm CABEÇA CHATA PHILIPS SCREW 3,5x16 mm FLAT HEAD TORNILLO PHILIPS 3,5x16 mm CABEZA PLANA		4
F23 PARAFUSO PHILIPS 4x14mm CABEÇA PANELA PHILIPS SCREW 4x14 mm PAN HEAD TORNILLO PHILIPS 4x14 mm CABEZA ALOMADA		28	F25 PARAFUSO UNIÃO 28mm 28mm CONNECTOR SCREW TORNILLO DE UNIÃO 28mm		4
F22 PARAFUSO PHILIPS 5x50mm CABEÇA FLANGEADA PHILIPS SCREW 5x50 mm FLANG HEAD TORNILLO PHILIPS 5x50 mm CABEZA CON BRIDA		8	F27 PARAFUSO MINIFIX 6x30mm 6x30mm CAM LOCK SCREW TORNILLO MINIFIX 6x30mm		3
F7 CAVILHA DE MADEIRA 8X30mm 8X30mm WOODEN DOWEL PIN TARUGO DE MADERA DE 8X30mm		14	F10 DISPOSITIVO FIXADOR DE FUNDO DE PLÁSTICO 15x14x12mm 15x14x12mm PLASTIC DRAWER EDGE FASTENING DEVICE DISPOSITIVO SUJETADOR DEL FONDO DE PLÁSTICO 15x14x12mm		4
F1 BATENTE DE SILICONE 12MM 12MM SILICONE BUMPER TOPE DE SILICONA 12MM		6	F2 BUCHA DE PAREDE PLÁSTICA DE 8mm 8mm PLASTIC WALL ANCHOR TACOS DE PARED PLASTIC DE 8mm		4
F33 TAMPA DE PLÁSTICO MINIFIX 15mm 15mm PLASTIC CAM LOCK COVER CUBIERTA DE PLÁSTICO MINIFIX 15mm		2	F34 TAPA FURO ADESIVO 12mm 12mm ADHESIVE HOLE COVERS CUBRE ORIFICIOS ADHESIVO DE 12mm		14
A7 DOBRADIÇA POP SLOWMOTION RETA 35 MM COM CALÇO - CÓDIGO 202633 35 mm SLOW-MOTION CURVE HINGE WITH STRAIGHT OVERLAY HINGE - CODE 202633 BISAGRA DE CIERRE CURVA LENTO CON CAZOLETA DE BISAGRA ALTA DE 35 mm - CÓDIGO 202633		4	A16 PÉS DE PLÁSTICO 100x50x50mm - CÓDIGO 202367 100x50x50mm PLASTIC FEET - CODE 202367 PIES DE PLÁSTICO 100x50x50mm - CÓDIGO 202367		4
F6 CAPA PLÁSTICA PARA CANTONEIRA 55X30X30mm 55X30X30mm PLASTIC COVER FOR CORNER BRACE TAPA DE PLÁSTICO PARA ÂNGULO 55X30X30mm		4	A14 PAR CORREIÇA TELESCÓPICA H35 350x30mm - CÓDIGO 202294 PAIR OF H35 350x30mm TELESCOPIC DRAWER - CODE 202294 CORREDERA TELESCÓPICA PAR H35 DE 350x30mm - CÓDIGO 202294		1